



Model PAC-SF28OF-E (Duct Flange for Fresh Air)
Installation Manual



*Before installing the optional parts, thoroughly read these instructions and the indoor unit installation manual.

Safety Notes:

- Carefully read this section "Safety Notes" and safely install the optional parts.
- Be sure to observe the cautions described here: They include critical contents for safety.
- The following indications show the classification of danger and subsequent results following incorrect installation.

 WARNING	Incorrect installation could lead to death or serious injury.
 CAUTION	Incorrect installation could lead to injury or damage to building and household articles.

- After installation, perform a test run and make sure that there is no abnormality. Then hand this manual to customer after explaining the "Safety Notes", use and cleaning of the device, etc.
- Ask your customer to keep this installation manual with the instruction manual. Also ask the customer to transfer these manuals to the new user if the user changes.

 WARNING	Ask the dealer or a specialist for installation. If installed incorrectly by user, could cause water leak, electric shock, fire, etc.
 WARNING	Carefully install the flange according to this installation sheet. Incorrect installation could cause water leak, electric shock, fire, etc.

1. Checking Provided Parts

- * Make sure that have all the following parts before installation:

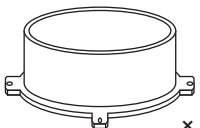
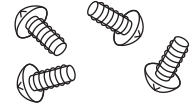
① Duct flange	② Tapping screws (4x10)
 × 1	 × 4

2. External Diagram of Duct Flange Unit: mm

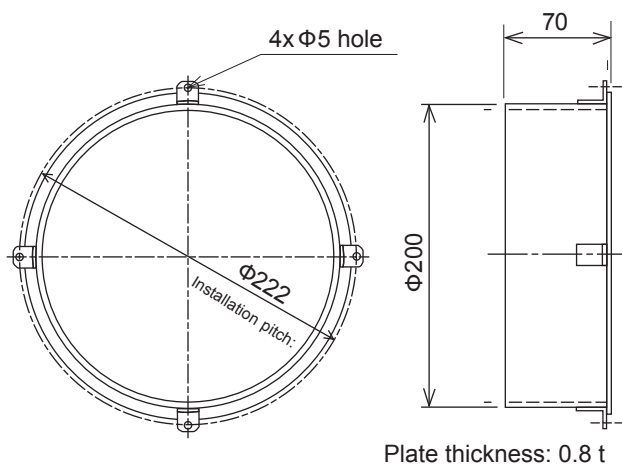

3. Duct Flange Installation Procedure

1. Punch out the knockout opening for installing duct on indoor unit.
2. Use the provided tapping screws ② to secure duct flange ①.

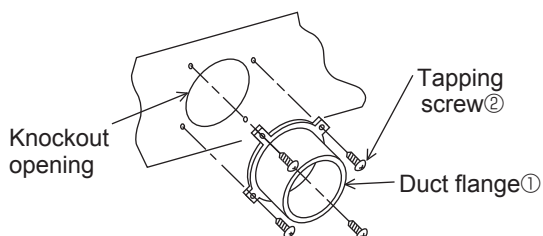

4. Duct Installation Procedure

1. Securely fix the duct (with inner diameter 200 mm) procured at local site to the duct flange, using screws or band.

